

# Up/Down Counter/Timer

## DIN W72 × H36mm of counter/timer with indication only

### ■ Features

- Upgraded counting speed : 1cps/30cps/2kcps/5kcps
- Application of Up/Down input mode
- Selectable Up/Down indication of display value
- Wide range of input power supply :  
100–240VAC 50/60Hz, 12–24VAC/DC
- Selectable Counter or Timer function by internal DIP switch
- Selectable time ranges
- Built-in Microprocessor



**⚠ Please read "Caution for your safety" in operation manual before using.**



### ■ Ordering information

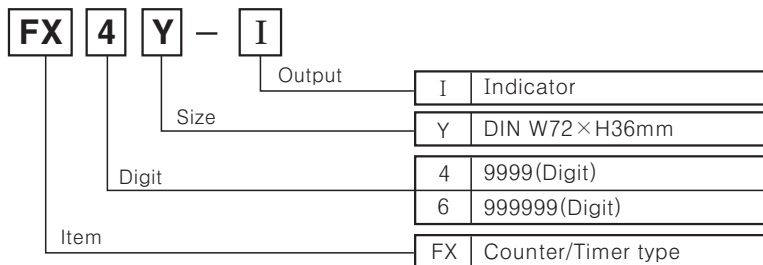

### ■ Specifications

Model		FX4Y-I	FX6Y-I
Digit		4	6
Digit size		W8 × H14mm	W4 × H8mm
Power supply		100–240VAC 50/60Hz, 12–24VAC/DC (Option)	
Allowable voltage range		90 to 110% of rated voltage	
Power consumption		Approx. 4.5VA (240VAC 60Hz), Approx. 4.5VA (24VAC 60Hz), Approx. 2.5W (24VDC)	
Max. counting speed		Selectable 1cps/30cps/2kcps/5kcps by internal DIP switch	
Min. input signal width	INHIBIT input	Min. 20ms	
	RESET input		
Input	CP1, CP2 input	No voltage input ⇒ Impedance at short-circuit : Max. 470Ω, Residual voltage at short-circuit : Max. 1VDC, Impedance at open-circuit : Min. 100kΩ	
	RESET input		
Memory protection		10 years (When using non-volatile semiconductor memory)	
External power		12VDC ± 10% 50mA Max.	
Insulation resistance		Min. 100MΩ (at 500VDC megger)	
Dielectric strength		2000VAC 50/60Hz for 1 minute	
Noise strength	AC type	± 2kV the square wave noise (pulse width : 1μs) by the noise simulator	
	DC type	± 500V the square wave noise (pulse width : 1μs) by the noise simulator	
Vibration	Mechanical	0.75mm amplitude at frequency of 10 to 55Hz in each of X, Y, Z directions for 1 hour	
	Malfunction	0.5mm amplitude at frequency of 10 to 55Hz in each of X, Y, Z directions for 10 minutes	
Shock	Mechanical	300m/s <sup>2</sup> (Approx. 30G) in X, Y, Z directions for 3 times	
	Malfunction	100m/s <sup>2</sup> (Approx. 10G) in X, Y, Z directions for 3 times	
Ambient temperature		–10 to 55°C (at non-freezing status)	
Storage temperature		–25 to 65°C (at non-freezing status)	
Ambient humidity		35 to 85%RH	
Approval			
Unit weight		AC type: Approx. 126g, DC type: Approx. 130g	AC type: Approx. 128g, DC type: Approx. 132g

- (A) Photo electric sensor
- (B) Fiber optic sensor
- (C) Door/Area sensor
- (D) Proximity sensor
- (E) Pressure sensor
- (F) Rotary encoder
- (G) Connector/Socket
- (H) Temp. controller
- (I) SSR/Power controller
- (J) Counter**
- (K) Timer
- (L) Panel meter
- (M) Tacho/Speed/Pulse meter
- (N) Display unit
- (O) Sensor controller
- (P) Switching power supply
- (Q) Stepping motor & Driver & Controller
- (R) Graphic/Logic panel
- (S) Field network device
- (T) Production stoppage models & replacement

# FXY Series

## Connections

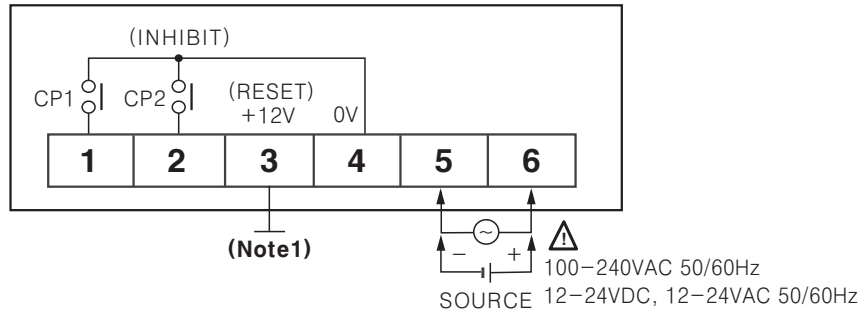

- ※ **(Note 1)** It can be selected RESET or sensor power(+12VDC 50mA) by internal PIN operation.(Refer to J-39)
- ※ CP1, CP2 : Input signal terminals when using as counter.
- ※ INHIBIT(CP2) : Time Hold terminal when using for timer (Connect switch to ②+④ from the external.)
- ※ Operated by a Power ON Start method when it is used as a timer.

## Input connections

◎ Using for no-voltage input (NPN)

● Solid-state input (Standard sensor : NPN output type sensor)

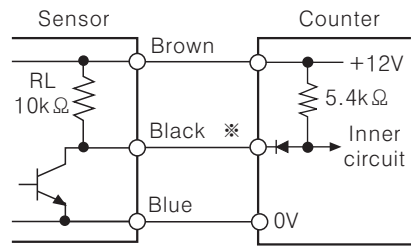

(NPN output)

※ CP1, CP2(INHIBIT), RESET input

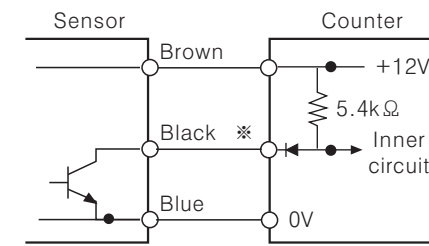

(NPN open collector output)

● Contact input

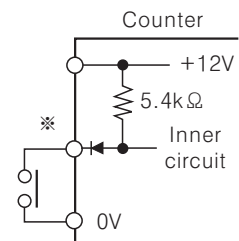

※ Please select the counting speed as 30cps when using for counter.

◎ Using for voltage input (PNP)

FXY series is for no-voltage input type, it is not available to count applying DC voltage from the external. For using PNP type sensor, please use as the following to count.

● PNP output type sensor

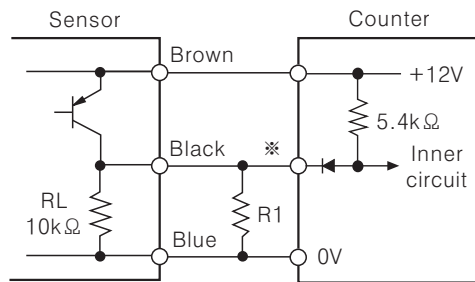

(PNP output)

● Please set R1 value to make the composed resistance of  $RL + R1$  as Max.  $470k\Omega$  is an impedance for short-circuit.

※ CP1, CP2(INHIBIT), RESET input

● PNP open collector output type sensor

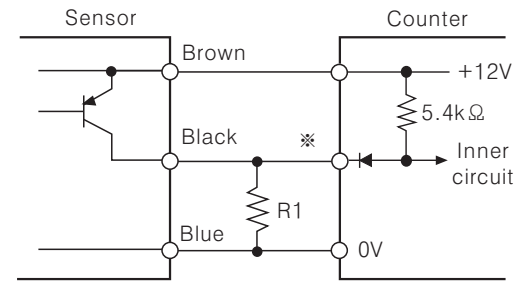

(PNP open collector output)

※ In case of PNP open collector output type sensor, please connect lower than  $470\Omega$  of R1 to input terminal before using.

# Up/Down Counter/Timer

## Counting method

Be careful to select sensor because the counting method of NPN output type sensor is different from PNP output type sensor.

### ●NPN output type sensor

: When the sensor is changed from OFF to ON, it counts.

### ●PNP output type sensor

: When the sensor is changed from ON to OFF, it counts.

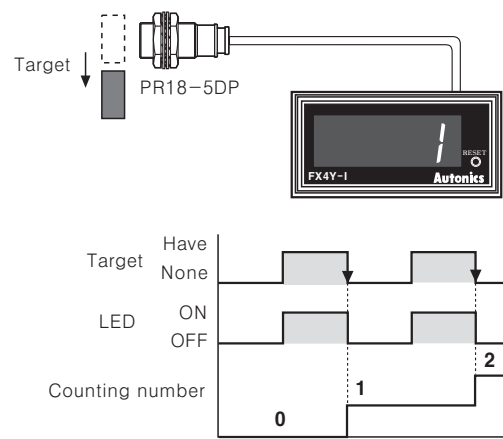
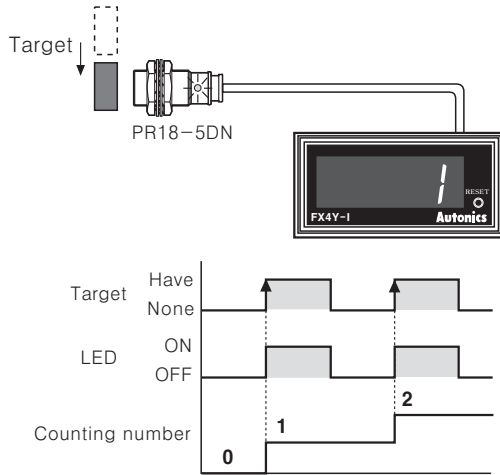

## Dimensions

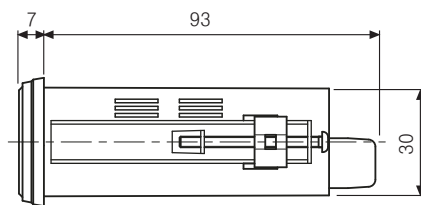
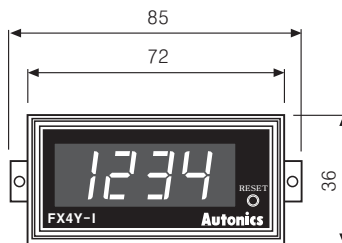

### ●Panel cut-out

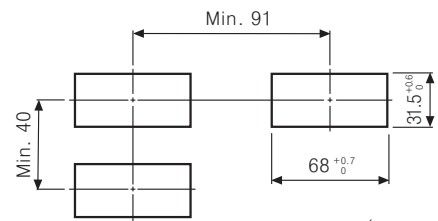

(Unit:mm)

## Counting operation of indication type(Counter)

### ●Up mode

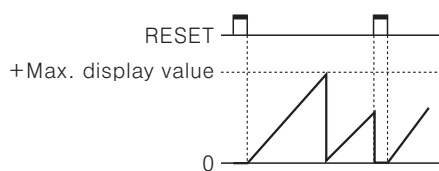

### ●Down mode

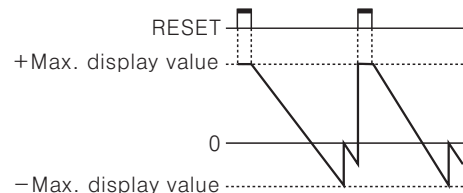

### ●Up/Down-A, B, C mode

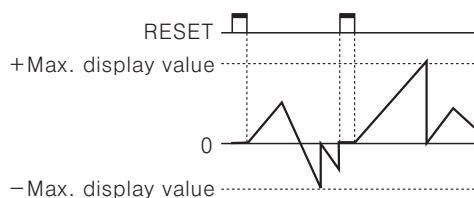

### ●Up/Down-D, E, F mode

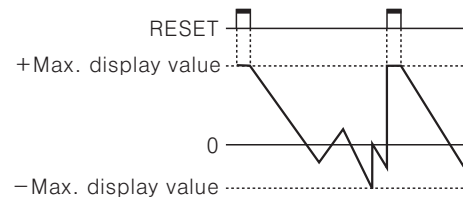

## Counting operation of indication type(Timer)

### ●Up mode

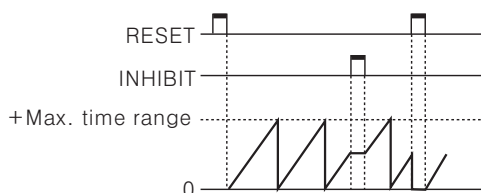

### ●Down mode

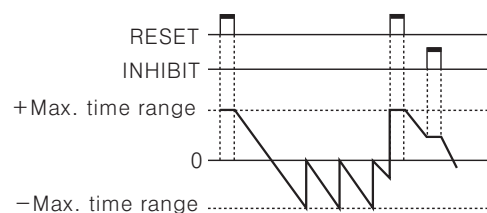

(A) Photo electric sensor

(B) Fiber optic sensor

(C) Door/Area sensor

(D) Proximity sensor

(E) Pressure sensor

(F) Rotary encoder

(G) Connector/Socket

(H) Temp. controller

(I) SSR/Power controller

(J) Counter

(K) Timer

(L) Panel meter

(M) Tacho/Speed/Pulse meter

(N) Display unit

(O) Sensor controller

(P) Switching power supply

(Q) Stepping motor & Driver & Controller

(R) Graphic/Logic panel

(S) Field network device

(T) Production stoppage models & replacement

# FXY Series

## ■ Description of inner DIP switches

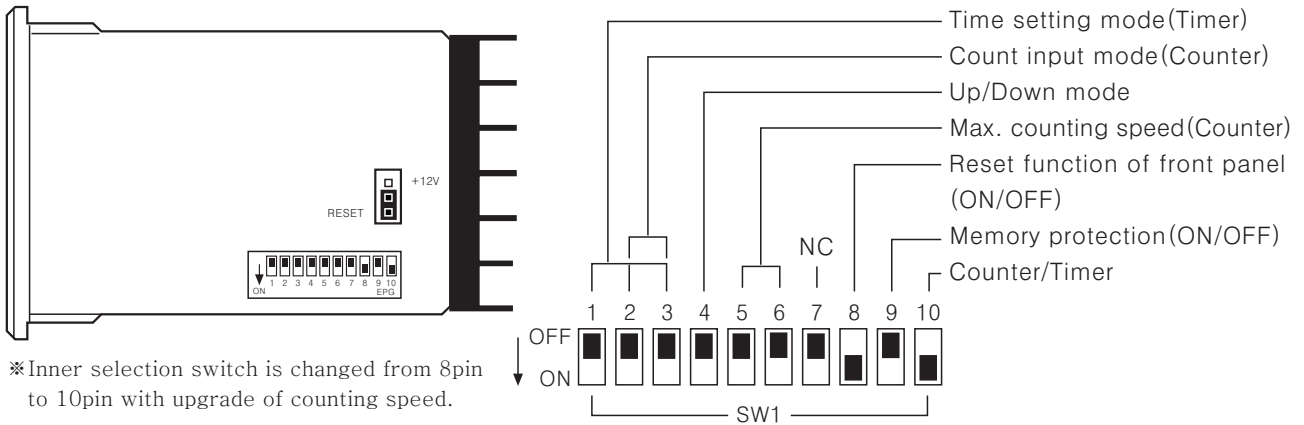

### ●Up/Down mode

SW1	Function
4 OFF <input type="checkbox"/> ON <input type="checkbox"/>	Up mode
4 OFF <input type="checkbox"/> ON <input type="checkbox"/>	Down mode

### ●Counter/Timer

SW1	Function
10 OFF <input type="checkbox"/> ON <input type="checkbox"/>	Timer
10 OFF <input type="checkbox"/> ON <input type="checkbox"/>	Counter

### ●Reset function of front panel(ON/OFF)

SW1	Function
8 OFF <input type="checkbox"/> ON <input type="checkbox"/>	Disable the front panel reset function
8 OFF <input type="checkbox"/> ON <input type="checkbox"/>	Enable the front panel reset function

### ●Max. counting speed

SW1	CP1, CP2
5 6 OFF <input type="checkbox"/> ON <input type="checkbox"/>	1cps
5 6 OFF <input type="checkbox"/> ON <input type="checkbox"/>	30cps
5 6 OFF <input type="checkbox"/> ON <input type="checkbox"/>	2kcps
5 6 OFF <input type="checkbox"/> ON <input type="checkbox"/>	5kcps

### ●Memory protection(ON/OFF)

SW1	Function
9 OFF <input type="checkbox"/> ON <input type="checkbox"/>	Enable the memory protection
9 OFF <input type="checkbox"/> ON <input type="checkbox"/>	Disable the memory protection

## ■ Time setting mode(Timer)

SW1	4Digit	6Digit	SW1	4Digit	6Digit
<b>A</b> OFF <input type="checkbox"/> <input type="checkbox"/> <input type="checkbox"/> ON <input type="checkbox"/> <input type="checkbox"/> <input type="checkbox"/>	<b>99.99sec.</b>	<b>99999.9sec.</b>	<b>E</b> OFF <input type="checkbox"/> <input type="checkbox"/> <input type="checkbox"/> ON <input type="checkbox"/> <input type="checkbox"/> <input type="checkbox"/>	<b>999.9min.</b>	<b>99999.9min.</b>
<b>B</b> OFF <input type="checkbox"/> <input type="checkbox"/> <input type="checkbox"/> ON <input type="checkbox"/> <input type="checkbox"/> <input type="checkbox"/>	<b>999.9sec.</b>	<b>999999sec.</b>	<b>F</b> OFF <input type="checkbox"/> <input type="checkbox"/> <input type="checkbox"/> ON <input type="checkbox"/> <input type="checkbox"/> <input type="checkbox"/>	<b>99hour 59min.</b>	<b>99hour 59min 59sec.</b>
<b>C</b> OFF <input type="checkbox"/> <input type="checkbox"/> <input type="checkbox"/> ON <input type="checkbox"/> <input type="checkbox"/> <input type="checkbox"/>	<b>9999sec.</b>	<b>99min. 59.99sec.</b>	<b>G</b> OFF <input type="checkbox"/> <input type="checkbox"/> <input type="checkbox"/> ON <input type="checkbox"/> <input type="checkbox"/> <input type="checkbox"/>	<b>999.9hour</b>	<b>9999hour 59min.</b>
<b>D</b> OFF <input type="checkbox"/> <input type="checkbox"/> <input type="checkbox"/> ON <input type="checkbox"/> <input type="checkbox"/> <input type="checkbox"/>	<b>99min. 59sec.</b>	<b>999min. 59.9sec.</b>	<b>H</b> OFF <input type="checkbox"/> <input type="checkbox"/> <input type="checkbox"/> ON <input type="checkbox"/> <input type="checkbox"/> <input type="checkbox"/>	<b>9999hour</b>	<b>99999.9hour</b>

# Up/Down Counter/Timer

## Input mode(Counter)

Input mode	SW1	4 OFF ON <b>Up mode</b>	Input mode	SW1	4 OFF ON <b>Down mode</b>
Up/Down-A (Command input)	OFF 2 3 ON		Up/Down-D (Command input)	OFF 2 3 ON	
Up/Down-B (Individual input)	OFF 2 3 ON		Up/Down-E (Individual input)	OFF 2 3 ON	
Up/Down-C (Phase difference input)	OFF 2 3 ON		Up/Down-F (Phase difference input)	OFF 2 3 ON	
UP (Count up input)	OFF 2 3 ON		Down (Count down input)	OFF 2 3 ON	

※Ⓐ : Over min. signal width, Ⓑ : Over 1/2 of min. signal width.

If the signal width of Ⓐ or Ⓑ is less than min. signal width, ±1 of count error is occurred.

※n : + max. display value (FX4Y-I : 9999, FX6Y-I : 999999)

(A) Photo electric sensor

(B) Fiber optic sensor

(C) Door/Area sensor

(D) Proximity sensor

(E) Pressure sensor

(F) Rotary encoder

(G) Connector/Socket

(H) Temp. controller

(I) SSR/Power controller

(J) Counter

(K) Timer

(L) Panel meter

(M) Tacho/Speed/Pulse meter

(N) Display unit

(O) Sensor controller

(P) Switching power supply

(Q) Stepping motor & Driver & Controller

(R) Graphic/Logic panel

(S) Field network device

(T) Production stoppage models & replacement

# FXY Series

## ■ Proper usage

### ◎ Reset

#### ● Reset

When selecting a reset input/output mode, please apply the external reset or manual reset signal.

**If it is not reset, it is operated as the prior mode.**

#### ● Reset signal width

It is reset perfectly when the reset signal is applied for **min. 20ms** regardless of the contact input & solid-state input.

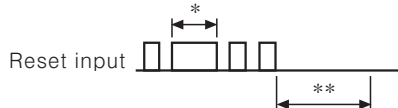

\*In case of a contact reset, it is reset perfectly if the ON time of reset signal is applied for min. 20ms even though a chattering is occurred.

\*\*Signal input (CP1, CP2) is possible if there is no reset input for min. 50ms after reset input.

### ◎ Min. signal width

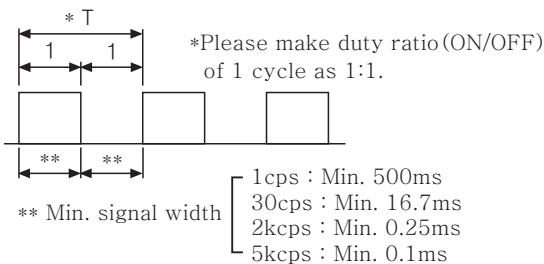

### ◎ Max. counting speed

This is a response speed per 1 sec. when the duty ratio (ON:OFF) of input signal is 1:1.

If the duty ratio is not 1:1, the width between ON and OFF should be over min. signal width and the response speed will get slower against input signal. And one of ON width and OFF width is under min. signal width, this product may not response.

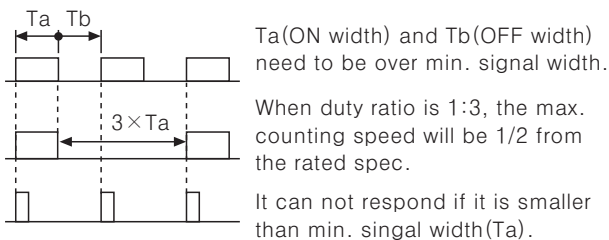

### ◎ Detach the case from body

While pushing the Lock part with with driver to the front, push the terminal block.

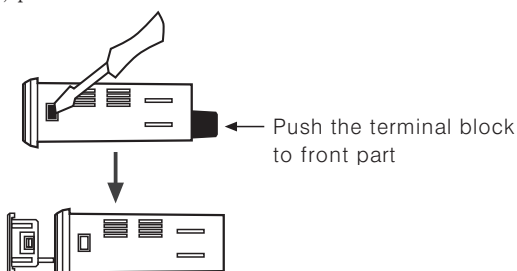

### ◎ Using switching pin of Reset / +12V

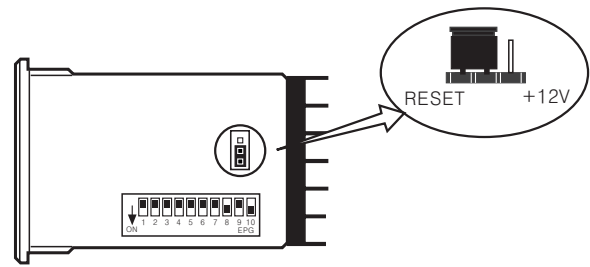

#### ● When using terminal 3 for external reset terminal

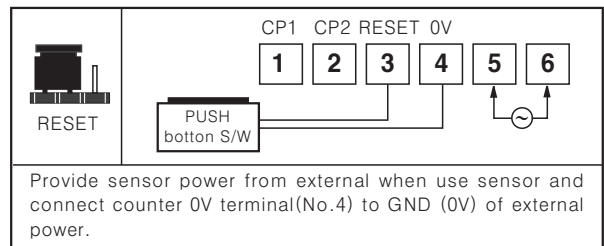

#### ● When using terminal 3 for sensor power terminal

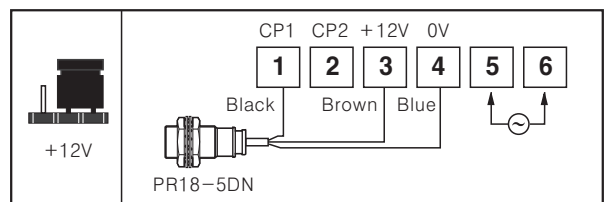

### ◎ INHIBIT [For timer]

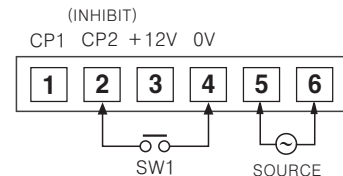

- It becomes the INHIBIT mode when SW1 turns on. (Time Hold)
- When power is applied, it starts to progress and INHIBIT mode is used to stop the time is under the progress at the moment.
- When SW1 is OFF, timer starts to progress again.

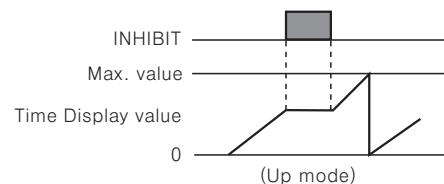

### ◎ Power

The inner circuit voltage starts to rise up for the first 100ms after power on, the input may not work at this time. And also the inner circuit voltage drops down for the last 500ms after power off, the input may not work at this time.

